

Product Specification

Product Class: LED LENS

Item No:**SOL-LS23570-28H1-90**

Material: PC (UV)

Certification: RoHS

Content

Specification-----	3
2D Drawing-----	4
Optical Datasheet-----	5
Packing-----	6
Application Notes-----	7

Specification

Item No	Picture	Size	Matched LED	Lighting Application
SOL-LS23570-28H1-90		Diameter: 236*70mm Height:6.6mm FWHM:90°	5050	High Bay Light

Drawing

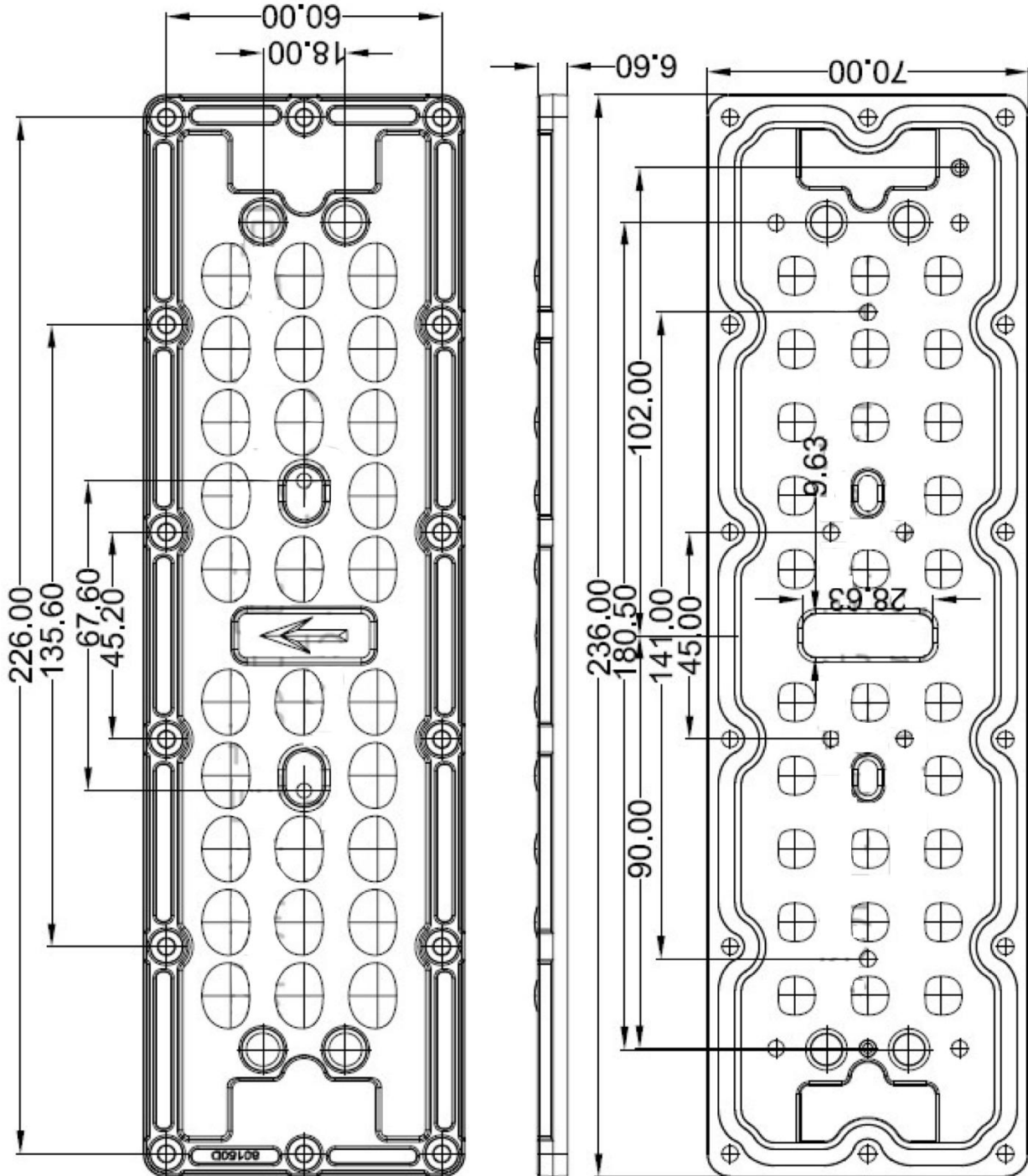

Optical Test Report

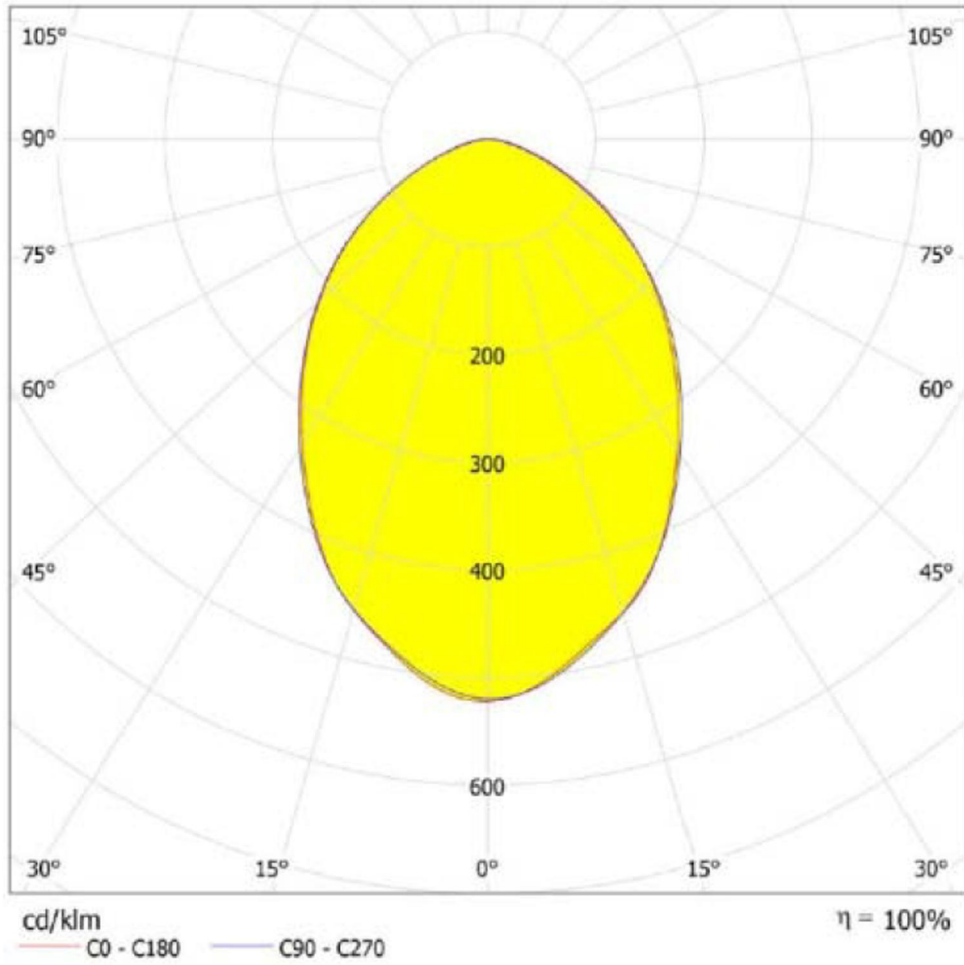

Packing

Material	Size	Packing Instruction
EPE	315*230mm	44PCS/1 Box 4 Box/1 Carton
Plastic bag	200*190mm	
White Paperboard	A level; 400g; 310*235mm	
Box	335*245*105mm	
Carton	A=B 510*330*255mm	

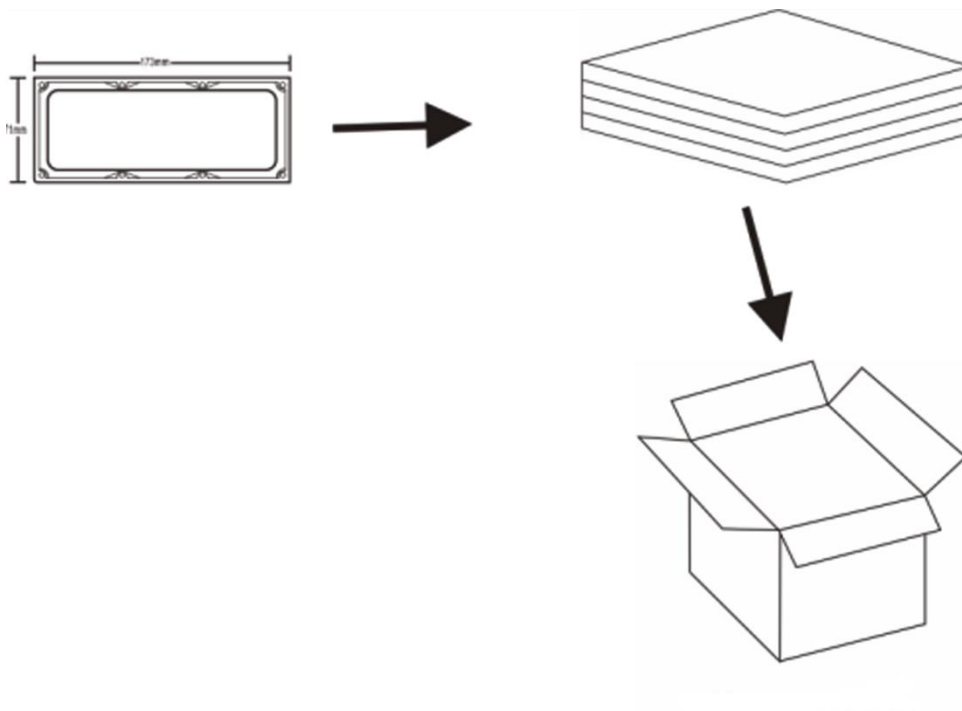

Application Notes

- (1) Please use a litter water and soft fabric (air-laid paper) to clean the product if necessary.
- (2) Forbid to use industrial solvent to clean the product, such as alcohol.
- (3) The working temperature is $-35^{\circ}\text{C}\sim+120^{\circ}\text{C}$.
- (4) Storage environment temperature is $0^{\circ}\text{C}\sim40^{\circ}\text{C}$, humidity is 30%~95%.
- (5) The product has the function to change the ray of light, it is made of optical material, the effect shall be influenced once pollute. Please do not open the packing before use it, to avoid the dust pollution.
- (6) Protect the product from the sun and other ultraviolet ray, as these will lead to aging, change color, crack, etc.
- (7) Please ware gloves once install the product, avoid to abrasion the product surface.
- (8) Forbid to use acidic or alkaline solution touch the product, avoid to generate the chemical reactions.

Thank You!

