

D Series Touch Panel



D7



1. Technical Specs:

- Input Voltage: 12-24Vdc
- Output Signal: DMX512
- Control Mode: 4 Zones Control
- Working Temperature: -30°C~55°C
- Dimensions: L86×W86×H36(mm)
- Package Size: L113×W112×H50(mm)
- Weight(G.W.): 208g

2. Installation Instruction:

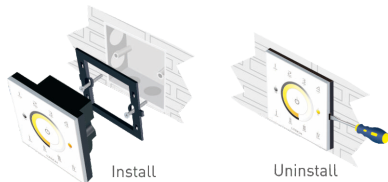

3. Product Size:

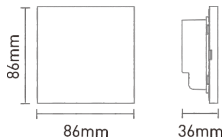

4. Key Functions:

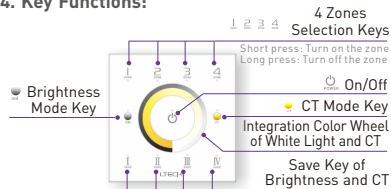

* Long press to turn on/off the tone.

5. Terminals:

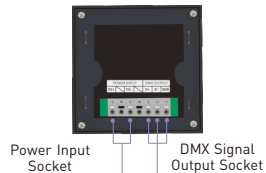

6. Wiring Diagram:

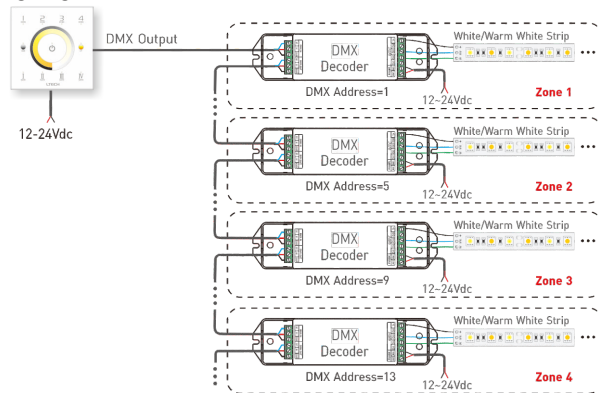

Multiple DMX decoders and lamps can be connected in each zone.